

**SERVICE INSTRUCTIONS** The INSURGICAL Drill is a single-use device. If the device fails to operate, ensure the mode switch is in the UNLOCK position, and retry. If the device remains inoperable, refer to the Intraoperative Battery Replacement Protocol to replace the battery. **CAUTION:** Battery is not sterile. If the device remains inoperable after battery replacement, transfer it off the sterile field to the circulating person. **DO NOT SERVICE** while in use with patient.

Contact INSURGICAL for complaint reporting at: [quality@insurgical.com](mailto:quality@insurgical.com)



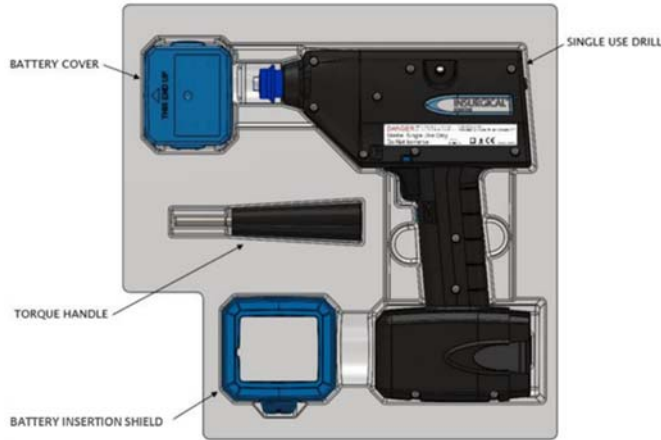

**DISPOSAL INSTRUCTIONS** Remember to **REMOVE battery before disposal**. Dispose of this product as medical waste. For more information, please visit [www.insurgical.com](http://www.insurgical.com).

**BATTERY CARE & MAINTENANCE** Reference Battery Instructions for Use (Document # 110-2009-001)

**TRAY CONTENTS**



**IMPORTANT: TO PREVENT INJURIES, THE MODE SWITCH OF THE HAND PIECE SHOULD BE IN THE LOCK  POSITION WHEN INSERTING OR REMOVING ATTACHMENTS.**

ENVIRONMENTAL SPECIFICATIONS			
Storage Temperature	-40°C  70°C		
Operating Condition	0°C  28°C	5%  95%	 >2.5KPa

*Caution: Federal Law (USA) restricts this device to sell by or on the order of a physician.*



**INDICATIONS FOR USE** INSURGICAL® Single Use Power Equipment is intended for use in the cutting, drilling, decorticating, and smoothing of bone and other bone related tissue in a variety of surgical procedures. It is also useable in the placement or cutting of bone screws, wires, pins, and other fixation devices. It can also be used to cut metal.

**CONTRAINDICATIONS** None

**DEVICE DESCRIPTION** The INSURGICAL Drill is a hand-held, sterile, single-use bone cutting device for use in orthopedic surgical procedures. The Drill receives power via a rechargeable battery.

**STERILIZATION** INSURGICAL hand-held devices are STERILE. INSURGICAL utilizes Ethylene Oxide for the sterilization method. Contents of tray are sterile unless opened or damaged. If tray or lid is opened, damaged, or if USE BY Date is exceeded, **DO NOT USE. SINGLE-USE. DO NOT RE-STERILIZE.**

- WARNINGS & PRECAUTIONS**
- 1) INSURGICAL hand-held devices are for use by properly trained personnel.
  - 2) The surgeon and all others in the area must wear eye protection while operating the device.
  - 3) To assure the safety of the patient and operating room personnel, use only INSURGICAL rechargeable batteries with INSURGICAL hand-held devices. Do not contact patient while holding battery.
  - 4) If the device is dropped, immersed or damaged in any way, **DO NOT USE** and dispose of properly.
  - 5) Prior to use, the device and accessories must be inspected for proper operation. If tray or lid is opened, damaged or if USE BY Date is exceeded, **DO NOT USE.**
  - 6) **DO NOT RE-STERILIZE. DO NOT RE-USE.** Dispose of the device as medical waste. INSURGICAL hand-held devices are **SINGLE USE ONLY.** Re-Use of these devices will increase risk of infection.
  - 7) No modification to the hand held device is allowed.

- SAFETY INSTRUCTIONS**
- 1) The mode switch, located below the trigger, should be in the LOCK  position whenever changing attachments, inserting or removing battery, or anytime device is not in use.
  - 2) Prior to use always check battery case for any cracks or other damage. Do not use damaged battery.
  - 3) Prior to use, always check battery charge level by pressing TEST  on the battery charge indicator gauge.
  - 4) Before use, be certain that attachments are correctly affixed to the device.
  - 5) Single-use attachments are recommended. Dull or worn attachments may cause heat buildup in the device and in the bone. Overheating can cause injury to patient or surgical personnel.



**SPECIFICATIONS** Type BF Electrical Equipment  
Battery: Lithium Ion  
Speed: 0-750 RPM  
Conforms to IEC 60601-1, Conforms to IEC 60601-1-2 for EMC

**DUTY CYCLE** Intermittent: 2 minutes ON and 1 minute OFF  
The device will turn off if heated by continuous operation.  
Allow the device to cool, check attachment for proper fixation and resume operation.

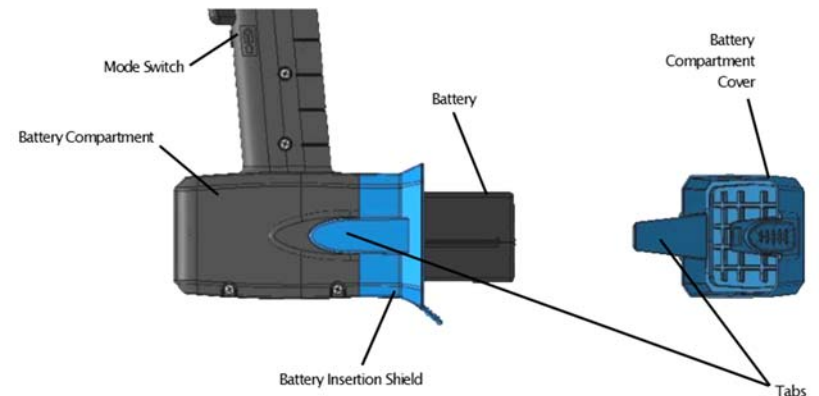
**INSTRUCTIONS FOR USE** Battery (Catalog # 3002022) Insertion / Removal





**INSTRUCTIONS FOR USE  
(con't)**

- 1) Circulating person: Remove the hand piece from outer package, and transfer to the sterile field using aseptic technique
- 2) Scrubbed person: Ensure the mode switch is in the LOCK  position.
- 3) Scrubbed person: Ensure battery insertion shield is affixed securely to the hand piece. The battery insertion shield helps guide the battery into the battery compartment and prevents contamination of the hand-piece by the non-sterile battery.
- 4) Circulating person: Determine battery charge level by pressing the TEST  button on the battery. A light on the battery will illuminate accordingly.

Green	Full Charge	Ready for Use
Blue	50% to 80% Charge	Not fully charged, continue charging
Yellow	Less than 50% Charge	Do Not Use, return battery to charger

- 5) Circulating person: Insert the battery through the battery insertion shield into the battery compartment, pressing down until the battery is fully seated. Remove the battery insertion shield.
- 6) Scrubbed person: Affix the battery compartment cover by guiding the tabs into the slots on each side of the battery compartment. Press firmly until the battery compartment cover is fully seated.
- 7) To remove the battery, pull while pressing the tabs on the battery compartment cover. Caution: Battery is not sterile. IMPORTANT: Please follow Intraoperative Battery Replacement Protocol when removal and replacement of battery is required.
- 8) To clean battery, wipe down with a cloth with a neutral enzymatic or neutral detergent solution before and after each use. IMPORTANT: do not use solvents to disinfect the batteries. Battery poles must not contact water or solvents: Danger of short circuiting! DO NOT STERILIZE BATTERY.
- 9)

**INTRAOPERATIVE  
BATTERY REPLACEMENT  
PROTOCOL**  
(Battery: Catalog # 3002022)

- 1) Scrubbed Person: Push the Mode Switch on the hand piece to the Lock  position.
- 2) Scrubbed Person: Hold the hand piece by its handle, with the battery compartment cover facing "up" towards the ceiling.
- 3) Scrubbed Person: To remove the battery compartment cover, pull while depressing the tabs on each side of the battery compartment cover. Transfer the battery compartment cover off the sterile field.
- 4) Scrubbed Person: Hold the hand piece so that the battery compartment is positioned outside the sterile field, and over a Mayo stand. Tap on the front of the battery compartment to dislodge the battery onto the Mayo stand.
- 5) Scrubbed Person: Affix the replacement battery insertion shield onto the battery compartment. The battery insertion shield helps guide the replacement battery into the battery compartment and prevents contamination of the hand-piece by the non-sterile battery.
- 6) Circulating Person: Determine the replacement battery charge level by pressing the TEST  button on the replacement battery. A light on the replacement battery will illuminate accordingly

Green	Full Charge	Ready for Use
Blue	50% to 80% Charge	Not fully charged, continue charging
Yellow	Less than 50% Charge	Do Not Use, return battery to charger









- 7) Circulating Person: Insert the replacement battery through the battery insertion shield into the battery compartment, pressing down until the replacement battery is fully seated. Remove the battery insertion shield.
- 8) Scrubbed Person: Affix the replacement battery compartment cover by guiding the tabs into the slots on each side of the battery compartment. Press firmly until the battery compartment cover is fully seated.



**DEVICE OPERATION**

- 1) To operate the device, push the mode switch to the UNLOCK position.
- 2) For clockwise rotation, push the rotation selection switch (located above the trigger) to the "F" position. For counter clockwise rotation, push the rotation selection switch to the "R" position. For a neutral setting, push the rotation selection switch so that it rests between the "F" and "R" position.
- 3) The device is supplied with a Zimmer® type coupling. Only attachments with Zimmer® style connector should be used.
- 4) The device is supplied with a torque handle that can be used to augment stabilization of the device while in operation.
- 5) The mode switch should be in the LOCK  position when changing attachments or when not in use.

**EXPLANATION OF  
SYMBOLS**

	Slide trigger lock in the up position to lock trigger
	Forward or clockwise rotation of chuck when viewed from rear
	Reverse or counter clockwise rotation of chuck when viewed from rear
	Type BF applied part
	Operating instructions
	Caution
	Single Use Only
	Sterilized using ethylene oxide

**TROUBLE SHOOTING**

Problem	Possible Solutions
The hand piece will not operate.	- Is the battery charged? Check the LED indicator on battery prior to placement into the hand piece? - Is the battery correctly seated into the tool? Ensure that the battery door cover is on the tool. - Is the mode switch in the "unlock" position? The tool will not operate if the trigger is locked.
The hand piece unexpectedly turned off during use.	- Is the battery charged? Check the LED indicator on battery prior to placement into the hand piece? - Does the tool feel warm? Deviating from the specified Mode of Operation will heat the tool too much and the internal fuse will turn off power. Let the tool cool and the fuse will reset. - Was the tool straining when it turned off? The battery will stop and reset under heavy loads. Let the tool rest for 5 seconds and battery will reset.
The battery will not fit into the hand piece.	- Is the battery being inserted correctly? The battery and hand pieces are mechanically keyed to avoid incorrect insertion.
The sterile barrier is damaged	- Do not use and return to Insurgical
The battery indicator light is not green	- Do not use the battery, return the battery to the charger until it is fully charged and the light is green.